

New Learning Spaces



SCHOOL FURNITURE
CATALOGUE FOR THE
21ST CENTURY

EN | FR



“Education is the most powerful weapon which you can use to change the world.”

Nelson Mandela

NAUTILUS, innovative and quality solutions for school equipment and learning technologies.

NAUTILUS has 2 industrial units in southern Europe and its customers and distribution networks guarantee its presence in more than 30 countries.

Today NAUTILUS is a leading company in Portugal and a reference in the European market.

NAUTILUS développe des solutions innovantes et de qualité pour les équipements scolaires et les technologies d'apprentissage.

NAUTILUS dispose de 2 unités industrielles implantées dans le sud de l'Europe et ses clients et réseaux de distribution garantissent sa présence dans plus de 30 pays.

Aujourd'hui NAUTILUS est la société leader au Portugal et une référence sur le marché européen



PRODUCTION LINES

SECTEURS DE PRODUCTION

Carpentry

Our pieces go through experienced hands, followed by a finishing line that allows a superior quality.

Menuiserie

Nos pièces passent entre des mains expérimentées, avant de suivre vers une ligne de finition qui permet d'obtenir une qualité supérieure.

Metalworking

Transformation of tube and sheet metal components. Epoxy painting finishings.

Serrurerie

Transformation de composants en tuyaux et plaques. Finitions par le biais de la ligne de peinture époxy.

Polymer injection

Fully automated gas-assisted injection line to enable mass production efficiently.

Injection de polymères

Ligne d'injection assistée par gaz, totalement automatisée, de manière à permettre la production de masse en toute efficacité.



NAUTILUS began its journey in 1996 with the production of home furniture. In 1999, the company started dedicating itself to the production of school furniture, with recognized success. Today, NAUTILUS' activity is more comprehensive, consisting in the production of wood, metal and polypropylene furniture for communities in general: offices, libraries, churches, museums and other specific projects.

NAUTILUS a démarré son activité en 1996 avec la production de meubles pour la maison. En 1999, l'entreprise se consacre à la fabrication de mobilier scolaire, avec un succès reconnu. Aujourd'hui, l'activité de NAUTILUS est plus globale, consistant en la production de mobilier en bois, métal et polypropylène pour les collectivités en général : bureaux, bibliothèques, églises, musées et autres projets spécifiques.





New Learning Spaces

SCHOOL FURNITURE
CATALOGUE FOR THE
21ST CENTURY



8. INNOVATIVE ENVIRONMENTS *AMBIANCES INNOVANTES*

- Digital Lab
L'École Numérique
- Versatile Environments
Environnements Polyvalents
- Pre-school
Maternelle
- Outdoor Learning
Classe Dehors
- Library
Bibliothèque
- Cafeteria
Réfectoire
- Lounge
Salon



24. TABLES *TABLES*



38. CHAIRS *CHAISES*

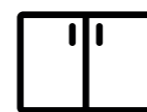

44. STORAGE *RANGEMENT*



52. BENCHES *BANCS*

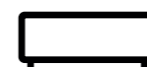

54. SOFT SEATING *POUFS*



56. ACOUSTIC PANELS *CLOISONS ACOUSTIQUES*



58. WHITE BOARDS *TABLEAUX D'ÉCRITURE*



60. TECHNOLOGY *TECHNOLOGIE*



68. REFERENCES *RÉFÉRENCES*



80. FINISHINGS *FINITIONS*



82. SIZE GUIDE *GUIDE DES TAILLES*



NAUTILUS
VIRTUAL CLASSROOMS



SCAN ME





Digital Lab

Along with diversified pedagogical models enriched by digital technologies, the physical learning space tends to have more and more personalized, flexible and multipurpose furniture, as it contributes to different ways of learning.

The space offers different typologies, with a natural integration between the physical and the online, enhancing new teaching and learning dynamics, individual and collective, essential to strengthen inclusive education and a quality school for the 21st century.

L'École Numérique

Parallèlement à des modèles pédagogiques diversifiés enrichis par les technologies numériques, l'espace d'apprentissage physique tend vers un mobilier plus personnalisé, flexible et polyvalent, car il contribue à différentes manières d'apprendre.

L'espace offre différentes typologies, avec une intégration naturelle entre le présentiel et le distanciel, qui favorisent de nouvelles dynamiques d'enseignement et d'apprentissage, individuelles et collectives, essentielles pour renforcer une éducation inclusive et une école de qualité pour le XXI siècle.





Versatile Environments

The creation of versatile and flexible learning environments allows schools to adapt to different learning styles and student needs, as well as to the short and long term changes that educational institutions go through.

The motivation of the students depends not only on the learning content but also on the surrounding environment and spaces.

DESK21 is ideal for flexible and dynamic learning environments, as they are quickly adaptable for both individual use and various collaborative learning styles. This line allows for numerous classroom layouts, with a quick and quiet layout reconfiguration.

Des environnements polyvalents

La création d'environnements d'apprentissage polyvalents et flexibles permet aux écoles de s'adapter aux différents modes d'apprentissage et aux besoins différents des élèves, ainsi qu'aux changements à court et long terme affrontés par les établissements scolaires.

La motivation des élèves ne dépend pas uniquement des contenus d'apprentissage mais également de l'environnement et de l'espace qui les entoure.

La ligne de tables DESK21 est idéale pour des environnements de travail flexibles et dynamiques, pouvant rapidement s'adapter autant à un usage individuel qu'à des styles variés d'apprentissage collaboratif. Cette ligne permet de créer une multitude de dispositions de salles de cours, leur reconfiguration étant rapide et silencieuse.







Pre-school

At this grade level, children learn to play. It is important to provide a welcoming, organized, but also stimulating environment.

Ergos One chairs provide the comfort and ergonomics that are fundamental in this phase of growth.

The multiple format activity tables (Ergmi and Desk 21) allow the creation of multifunctional environments that are ideal for the development of cognitive and social abilities.

Maternelle

À ce niveau d'enseignement, les enfants apprennent à jouer. Il est donc important de leur fournir un environnement accueillant, organisé mais également stimulant.

Les chaises Ergos One garantissent le confort et l'ergonomie essentiels à cette phase de croissance.

Les tables d'activités aux formats variés (Ergmi et Desk 21) permettent de créer des ambiances multifonctionnelles idéales pour le développement de la capacité cognitive et des aptitudes sociales.





Outdoor Learning

Exposure to nature has been shown to improve the physical, mental, and social health of children and adolescents.

Sensory development begins with outdoor exposure, so associating learning with the outdoors will result in more motivated, creative and healthy students.

Classe Dehors

L'exposition à la nature a révélé une amélioration de la santé physique, mentale et sociale des enfants et des adolescents.

Le développement sensoriel commençant par l'exposition à l'air libre, le fait d'associer l'apprentissage et l'extérieur donnera des élèves plus motivés, créatifs et en bonne santé.





Library

Today's libraries are comfortable, inviting spaces that engage and motivate students, making it the ideal environment to gather and share knowledge.

To develop the creative spirit in an ever-changing world, students and teachers need flexible spaces that are easy to reconfigure.

We design spaces adjusted to different learning models and to the specific needs of each school, favouring flexible furniture, connectivity, spaces for silent reading and spaces for collaborative work.

Bibliothèque

Les bibliothèques actuelles sont des espaces confortables et accueillants, qui attirent et motivent les élèves, étant l'environnement idéal pour se réunir et partager des connaissances.

Afin de développer leur esprit créatif dans un monde en constante évolution, élèves et professeurs ont besoin d'espaces flexibles facilement reconfigurables.

Nous concevons des espaces adaptés à différents modèles d'apprentissage et aux attentes spécifiques de chaque école, en privilégiant du mobilier flexible, la connectivité, les espaces de lecture silencieuse et les espaces de travail collaboratif.





Cafeteria

The variety of colours and the easy-to-clean Ergos One and Ergos Shell chairs allow you to create colourful environments full of positive energy.

A pleasant environment should include areas with soft seating to socialize, relax and regain energy, and high tables for quick meals or coffee break.

Réfectoire

La variété de couleurs et la facilité d'entretien des chaises Ergos One et Ergos Shell permettent de créer des environnements colorés et emplis d'énergie positive.

Un environnement agréable où se restaurer doit compter des zones avec des poufs où se rassembler, se détendre et récupérer de l'énergie, ainsi que des tables hautes pour des repas rapides ou des pauses café.





Informal Spaces

At Nautilus we design informal and open spaces that are ideal for socializing with colleagues, collaborate on projects, or take a coffee and snack break.

We value cozy, comfortable and multipurpose environments that combine meeting, cafeteria and lounge spaces.

Espaces de détente

Chez Nautilus, nous concevons des espaces informels et ouverts, idéaux pour partager des moments entre collègues, collaborer à des projets ou faire une pause pour prendre une collation ou un café.

Nous privilégions les environnements accueillants, pratiques et polyvalents, qui combinent zone de réunions, cafétéria et « lounge ».



TABLES / TABLES
ERGOS



Les tables ERGOS ont une surface lisse et sans bords vives, assurant un nettoyage facile et sécurité totale pour les enfants.

ERGOS, un choix ecoresponsable!

Sa production ne comprend pas de bois, donc, pas d'abatage d'arbres, sans colles, sans vernis ou peintures. Un produit monobloc sans besoin d'accessoires ou de pièces supplémentaires telles que vis, rivets, etc. Produite à partir de 75% de matériaux recyclés et entièrement recyclable et réutilisable dans la production de nouvelles chaises ou tables.



**Go Green,
Choose Eco-Friendly**

The ERGOS tables, have a smooth surface and no sharp edges, ensuring easy cleaning and total safety for the little ones.

ERGOS, a green choice!

It does not use trees because it does not use wood; without glues, varnishes or paints. Produced in a single mould, without accessories or separate pieces, like screws, rivets, etc. Produced from 75% recycled materials and fully recyclable and reusable in the production of new chairs or tables.



STRONG
Resistance to impact, scratches and wear

ROBUSTE
Résistance aux chocs, rayures et usure



WASHABLE
Sleek design for quick and easy cleaning

LAVABLE
Lavage simple est rapide



LIGHTWEIGHT
Lightness to easily move and arrange

LÉGER
Légère à déplacer, facile à ranger



CUSTOMIZABLE
Available in any colour with minimum order

PERSONNALISABLE
Autres couleurs sur demande



100% RECYCLABLE
Produced in a safe and non toxic material

100% RECYCLABLE
Fabrication avec des matériaux recyclés et non toxiques



UV PROTECTION
Prepared for UV disinfection

PROTECTION UV
Convient à l'intérieur comme à l'extérieur



DETACHABLE
Easy storage and transportation

PRATIQUE
Rangement et déplacement facile



ANTIBACTERIAL
Reduces bacterial by up to 99,9% (optional)

ANTIBACTÉRIEN
Réduit les bactéries jusqu'à 99,9%



TABLES / TABLES

MAIS

The MAIS table combines the traditional steel structure covered with epoxy paint and the modernity of the polypropylene used on the top.

Anticorrosive polyamide finishes, which protect from floor cleaning products.



CERTIFIED BY:



EN 1729 Parts 1 & 2 (European standard for dimensions, strength and stability).

La table MAIS allie la structure traditionnelle en acier recouverte de peinture époxy et la modernité du polypropylène utilisé sur le plateau.

Finitions anticorrosion en polyamide, qui protègent des produits de nettoyage du sol.



Terminal ajustável
Terminal ajustable



WASHABLE
Sleek design for quick and easy cleaning

LAVABLE
Conception lisse pour un nettoyage rapide



UV PROTECTION
Prepared for UV disinfection

PROTECCIÓN UV
Preparé pour la désinfection UV



100% RECYCLABLE
Produced in a safe and non toxic material

100% RECYCLABLE
Produit en matière fiable non toxique



TABLES / TABLES

DESK 21 U / I

Separate, join and create.
The DESK 21 U and I range offers the possibility to create different configurations within any school space. Compacmel® Top and metal structure with epoxy paint.

*Séparez, rejoignez et créez.
La gamme DESK 21 U et I offre la possibilité de créer différentes configurations dans n'importe lequel espace scolaire. Plateau Compacmel® et structure métallique peinture époxy.*

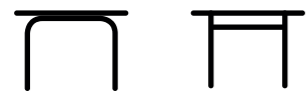

6x D21 IC6



1x D21 URO
2x D21 UMO



3x D21 URO



3x D21 UT



4x D21



8x D21 IC8

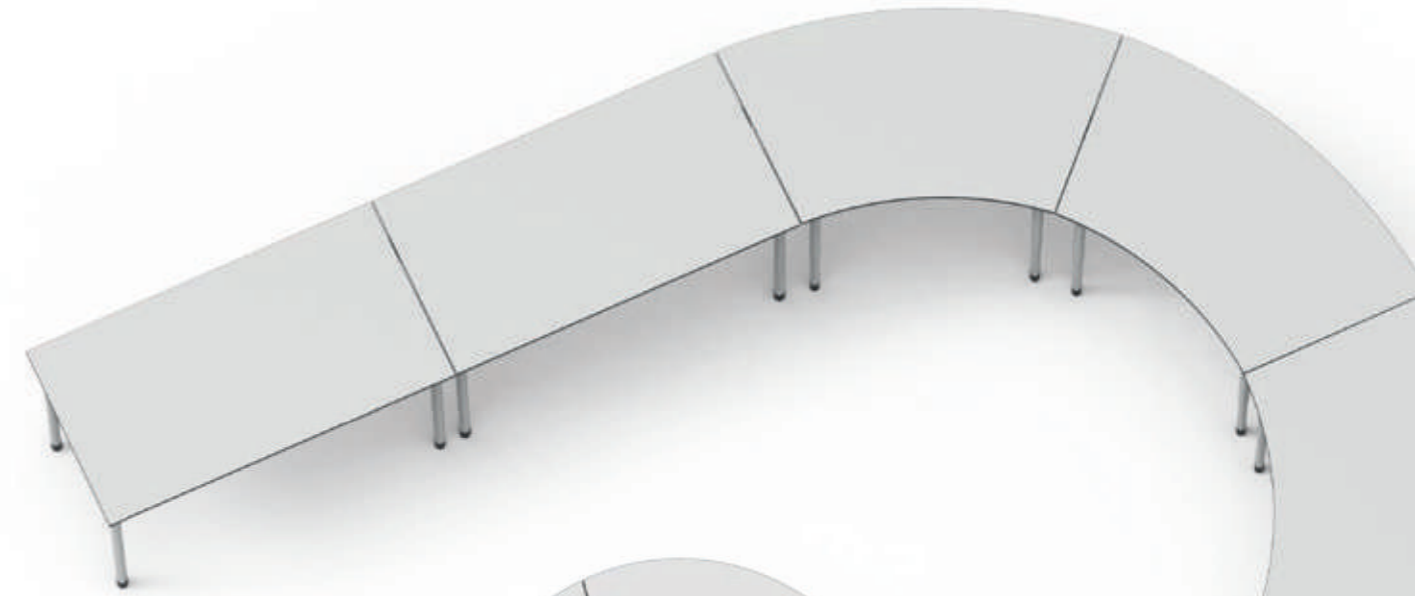

2x D21 URD
4 x D21 UC



2x D21 UMO

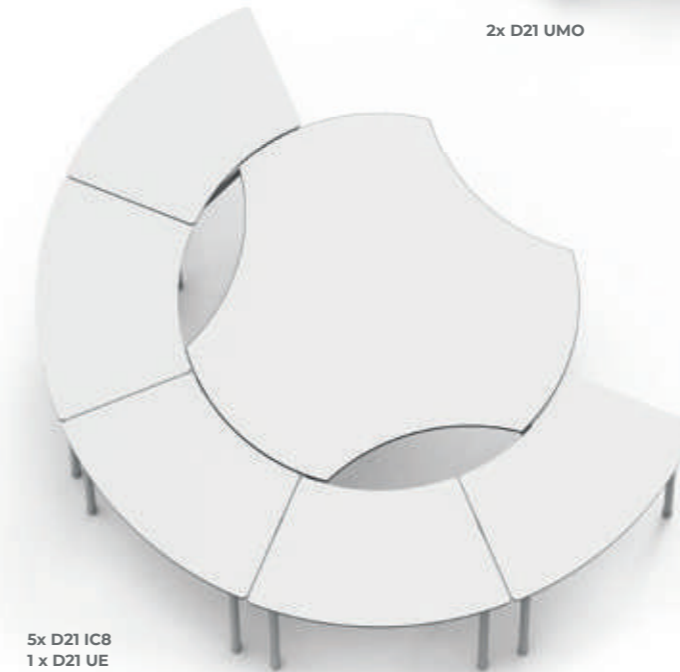

5x D21 IC8
1 x D21 UE

OPTION





TABLES / TABLES

DESK 21

Designed to allow different configurations in the same space, it enables a dynamic approach within the classroom, promoting not only interaction among the whole class, but also intergroup and one-on-one. With 3 positions, it allows left, right or center writing, responding to different needs of left-handed or right-handed students.

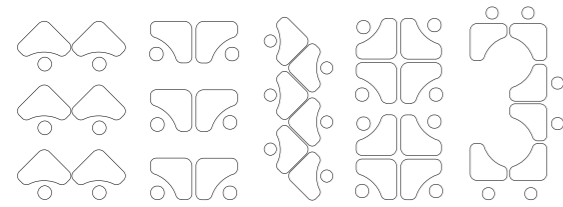

Conçu pour permettre différentes configurations dans un même espace, la table permet une approche dynamique au sein de la classe, favorisant pas seulement l'interaction entre toute la classe, mais également entre groupes et en vis à vis. Avec 3 positions, il permet d'écrire à gauche, à droite ou au centre. Desk21 répond aux besoins des élèves droitiers comme gauchers.



OPTION



STRONG
Robust and high quality materials
SOLIDITÉ
Matériaux robustes et de haute qualité

ERGONOMICS
Suitable for both right and left handed
ERGONOMIE
Convient aux droitiers et aux gauchers

ADJUSTABLE
Adjustable for correct posture
AJUSTABLE
Réglable pour une posture correcte

DETACHABLE
For an efficient transportation
PRATIQUE
Pour un déplacement plus efficace

EN EUROPEAN NORM
Dimensions according to EN 1729
NORME EUROPÉENNE
Dimensions selon norme

VERSATILE
Allows different configurations
POLYVALENT
permet différentes implantations de classe





TABLE TOP / PLATEAUX

ERGOS EDGE

The ERGOS EDGE tabletops use Polypropylene (PP) on the edges. Superior impact resistance when compared to rigid wooden or PVC edging. No glues or varnishes are used (no toxic products). The Polypropylene molded by injection is placed on the tabletop with a mold through high pressure injection, 800 Ton.

These tabletops edge's reduce damage to walls and other furniture that may be around. Options: pen holder, cup holder and leaf stopper.

ERGOS EDGE tabletops are adaptable to various types of metal frames.

Les plateaux ERGOS EDGE utilisent du polypropylène (PP) dans les chants, avec résistance supérieure aux chocs, par rapport aux chants en bois ou en PVC. Aucune colle ni vernis n'est utilisé (pas de produits toxiques). Le Polypropylène moulé par injection est posé sur le plateau avec un moule par injection à haute pression - 800 Tonnes.

Les chants en PP réduisent les dommages aux murs et autres meubles autour, lors du déplacement des tables. Options de plateaux: porte-stylo, porte-gobelet et porte-feuille.

Les plateaux ERGOS EDGE s'adaptent à différents types de structures métalliques.



RESISTANT

PP is fused into the wood fibers

RÉSISTANT

Le PP se fond dans les fibres du plateau



ECOLOGIC

No glues or varnishes

ÉCOLOGIQUE

Sans colles ni vernis



TABLES / TABLES

TEAM

The Team table line was developed with collaborative teaching models in mind. Adjustable height with under-top or drawer for storage. Tubular metal structure and top in Compacmel®.

Les tables TEAM ont été développées pour un modèle d'enseignement collaboratif. Réglable en hauteur et en angle. Structure métallique tubulaire peinte époxy et plateau en Compacmel®.



Casters
Roulettes



Lower tray
Sous-plateau



Adjustable
Réglable



Connection hook that allows the union between tables.

Système de raccordement qui permet l'union entre tables.



TABLES / TABLES

FLOW

Electric height adjustable table. Easy to adjust and use. Fits a more active work style, adapting to standing up work or seating at different seats height. The anti-shock feature reduces the likelihood of damage if the desk collides with a rigid object (e.g.: a drawer block).



OPTION

Table à hauteur réglable par commande électrique. Utilisation et réglage facile. Restez actif pendant plus longtemps. La ressource antichoc réduit la probabilité de dommages en cas de collision de la table avec un objet rigide (par exemple, caisson à tiroirs).



Version with double structure. The central panel designed especially for this version provides privacy and sound absorption

Version à double structure. Le panneau central, spécialement été conçu pour cette version, apporte confidentialité et isolation acoustique.



CHAIRS | CHAISES

MAIS

The MAIS chair combines the traditional steel structure with epoxy paint, and the modernity of the polypropylene used in the back and seat. Anticorrosive ends in polyamide, which protect from floor cleaning products

La chaise MAIS combine la structure traditionnelle en acier avec finition peinture époxy, et la modernité du polypropylène utilisé dans le dossier et l'assise. Bords anticorrosives et antibruit en polyamide.



MAIS UNI B



MAIS AA



MAIS BA



MAIS UNI AA



MAIS UNI AAR



WASHABLE

Sleek design for quick and easy cleaning

LAVABLE

Conception lisse pour un nettoyage rapide



UV PROTECTION

Prepared for UV disinfection

PROTECCIÓN UV

Convient à l'intérieur comme à l'extérieur



100% RECYCLABLE

Produced in a safe and non toxic material

100% RECYCLABLE

Produit en matière fiable non toxique



STACKABLE

Easy to carry and storage

EMPILABLE

Rangement et transport facile





CHAIRS / CHAISES

ERGOS ONE

A SUSTAINABLE CHOICE!

Made entirely of double-walled polypropylene, ERGOS ONE chairs have been tested and certified by FIRA INTERNATIONAL Lab, a leading authority on furniture testing in the world. ERGOS chairs comply with EN 1729 parts 1 and 2 (European standard for dimensions, resistance and stability).

UN CHOIX DURABLE!

Entièrement fabriquées en polypropylène à double paroi, les chaises ERGOS ONE ont été testées et certifiées par FIRA INTERNATIONAL Lab, une autorité leader sur les tests de meubles dans le monde. Les chaises ERGOS sont conformes à la norme EN 1729 parties 1 et 2 (norme européenne pour les dimensions, la résistance et la stabilité).



STRONG
Resistance to impact, scratches and wear

DURABLE
Résistance aux chocs, rayures et l'utilisation intensive



100% RECYCLABLE
Produced in a safe and non toxic material

100% RECYCLABLE
Fabrication avec des matériaux recyclés et non toxiques



WASHABLE
Sleek design for quick and easy cleaning

LAVABLE
Son design élégant et monobloc permet un lavage facile



UV PROTECTION
Prepared for UV disinfection

PROTECTION UV
Convient à l'intérieur comme à l'extérieur



LIGHTWEIGHT
Lightness to easily move and arrange

LÉGÈRE
Légère à déplacer, facile à ranger



STACKABLE
Easy to carry and storage

EMPILABLE
Facilité de transport et de rangement



CUSTOMIZABLE
Available in any colour with minimum order

PERSONNALISABLE
Disponible dans n'importe quelle couleur avec un minimum de commande



ANTIBACTERIAL
Reduces bacterial by up to 99,9% (optional)

ANTIBACTÉRIEN
Réduit les bactéries jusqu'à 99,9% (option)



SUPERIOR LUMBAR SUPPORT
Reduces fatigue caused by all-day sitting.

SUPPORT LOMBAIRE SUPÉRIEUR
Réduit la fatigue causée par une journée de travail.

CUTTOUT BACK
Allows lower back breathing for greater comfort.

DÉCOUPE AU DOS
Permet la respiration du bas du dos pour plus de confort.

SMOOTH EDGES
Seat's rounded edges designed for a proper knee flexion angle, helping blood circulation.

BORDS ARRONDI
Conçu pour un angle optimal de flexion du genou favorisant la circulation sanguine au niveau des jambes

ANTI-ROCKING
Back legs angle offers greater stability.

SYSTÈME ANTIBALANCEMENT
Pieds arrières anti-recul permettant une grande stabilité de la chaise



Go Green, Choose Eco-Friendly

CERTIFIED BY:
FIRA
EN 1729 Parts 1 & 2 (European standard for dimensions, strength and stability).





CHAIRS / CHAISES

ERGOS SHELL

Expanding the possibilities

All Ergos Shell models have as a common element, a gas-injected polypropylene hull, which combined with the various steel tube structures, origins different models, adapting to the needs of each space.



Élargir les possibilités

Tous les modèles Ergos Shell ont comme élément commun une coque en polypropylène à injection de gaz, qui combinée aux différentes structures en tube d'acier, donne naissance à différents modèles, s'adaptant aux besoins de chaque espace

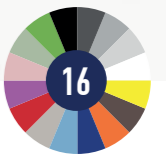

BASE

NOTE 360

POLE

ROCKING

ROCKING S

SPIN



STRONG

Resistance to impact, scratches and wear

ROBUSTE

Résistance aux chocs, rayures et l'utilisation intensive



WASHABLE

Sleek design for quick and easy cleaning

LAVABLE

Conception lisse pour un nettoyage rapide



UV PROTECTION

Prepared for UV disinfection

PROTECTION UV

Convient à l'intérieur comme à l'extérieur



100% RECYCLABLE

Produced in a safe and non toxic material

100% RECYCLABLE

100% RECYCLABLE Fabrication avec des matériaux



STORAGE | RANGEMENT

BOX

Storage and organisation solutions, designed to work with our ERGOS TRAY range. Cabinets in melamine with different configurations to combine with our BLOCK soft seating range.

Des solutions de rangement et d'organisation, conçues pour la gamme de bacs de rangement ERGOS TRAY. Armoires en mélamine avec différentes configurations à combiner avec notre gamme de poufs BLOCK.

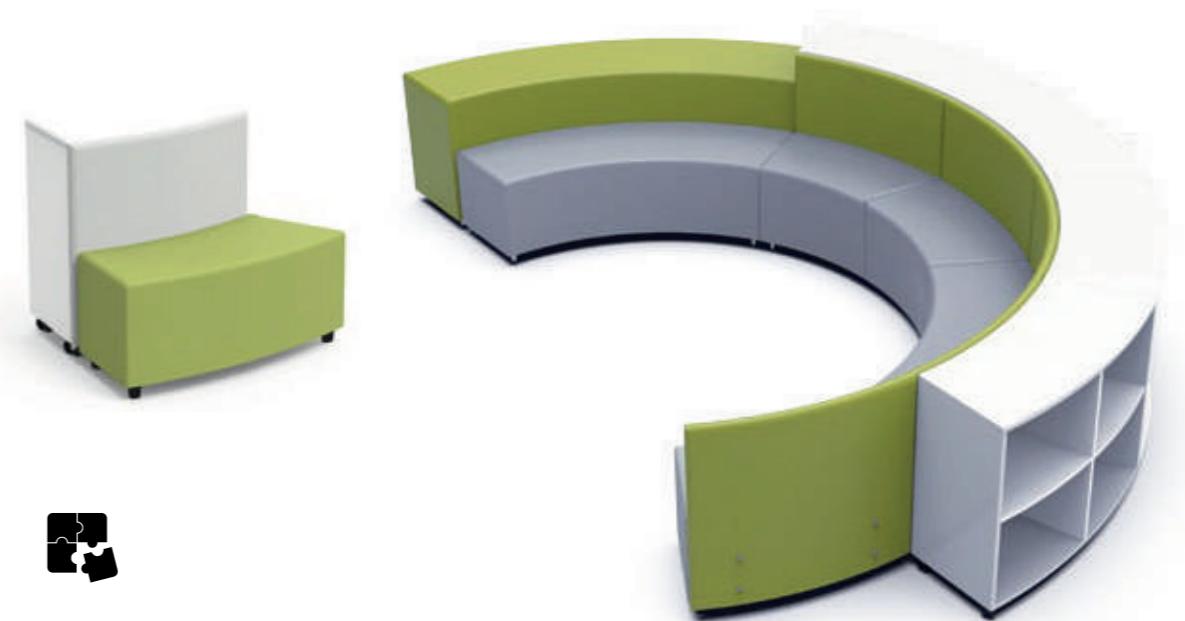

Different configurations that allow you to combine with our BLOCK soft seating line.

Différentes configurations qui permettent de réaliser de combinaisons avec notre gamme de poufs BLOCK.

5x **BLOCK: BLCPI**
1x **BLOCK: BLC** (T6 : L 1642)
1x **BLOCK: BLC** (T8 : L 2128)
4x **BOX: BCE/BCET**



STORAGE | RANGEMENT

RETA

The RETA line of shelving units ensures complete organization solutions for a wide variety of environments, namely libraries or office spaces.



La gamme d'étagères RETA garantit des solutions complètes d'organisation pour une large variété d'environnements, notamment des bibliothèques.



The shelves with melamine structures have a modular system with a variety of accessories in metal, melamine or mixed, for different purposes.

Les bibliothèques en mélamine ont un système modulaire avec une variété d'accessoires en métal, mélamine ou mixte, à des fins différentes.

Modules

METALLIC | MÉTALLIQUES



MELAMINE | MÉLAMINE

MIXED | MIXTES



STORAGE | RANGEMENT

KUBIC

Practical solutions for storage and organization, designed to work with our range of ERGOS TRAYS. With metal, melamine or wood structure our cabinets offer everything you need for maximum storage, allowing various configurations.



Des solutions de rangement pratiques, conçues pour fonctionner avec notre gamme de bacs ERGOS TRAY. Structure en métal, mélamine ou bois, nos armoires proposent tout ce qu'il vous faut pour un rangement maximal, avec plusieurs configurations possibles.

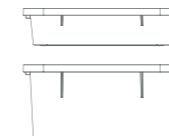
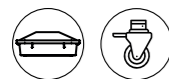

ERGOS TRAYS have a unique stacking system and can be stacked without the support of any structure, including contents.

Les bacs ERGOS TRAY ont un système d'empilage unique et peuvent être empilés sans le support d'aucune structure, y compris son contenu.



STORAGE | RANGEMENT

ATLANTIC

With the possibility of customization in terms of colors and number of compartments, these cabinets adapt to different spaces (corridors, rooms, dressing rooms). The closed version allows for safe storage of students' and teachers' personal belongings. In addition to the traditional lock (key or padlock option), these lockers can be equipped with an electronic lock system.



Avec la possibilité de personnalisation de couleurs et de nombre de cases, ces armoires s'adaptent à différents espaces (couloirs, chambres, vestiaires). La version fermée permet de ranger en toute sécurité les biens personnels des élèves et des enseignants. En plus de la serrure traditionnelle (option clé ou cadenas), ces casiers peuvent être équipés d'un système de serrure électronique

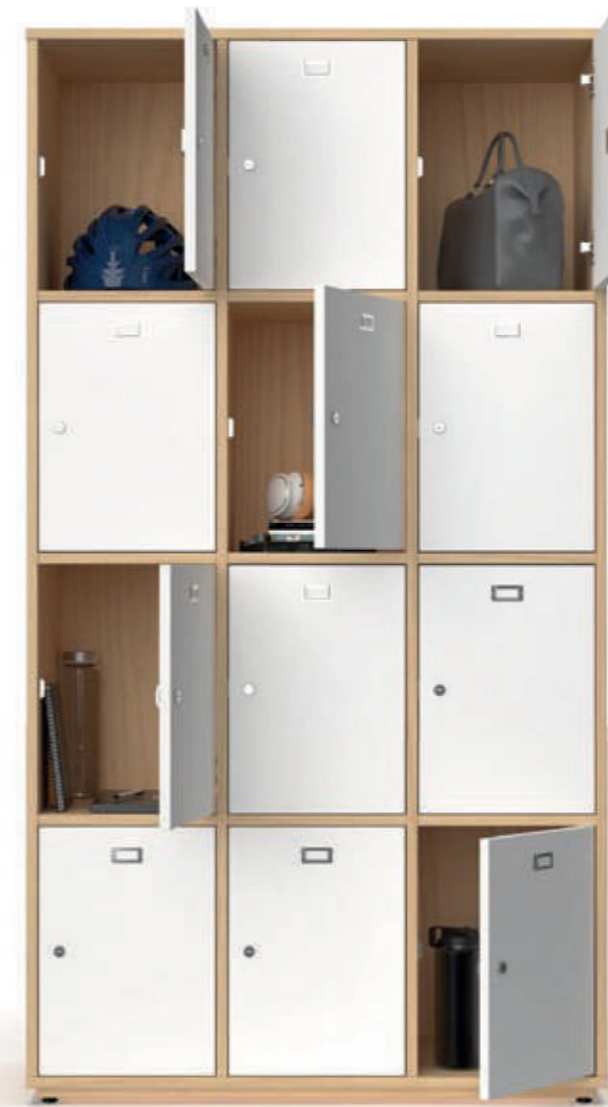

9, 12 or 15 cabinets
9, 12 o 15 casiers



Electronic lock (option)
Fermeture électronique (option)



Customizable colors
Couleurs personnalisables



STAND

This modular bench & storage system can have different dimensions and capacities, allowing the creation of group work and interaction areas, therefore being a part of libraries, classrooms, common spaces or auditoriums. Also includes multifunctional storage space. Option with upholstered in fabric or semi-leather.

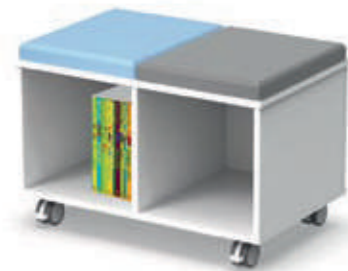

Ce système de gradins modulaires avec rangement se fait en différents formats et capacités, permettant de créer des différents espaces d'apprentissage et de diviser des espaces. Idéal pour le travail de groupe et pour améliorer l'interaction entre les étudiants. Pour utilisation en bibliothèques, salles de classe, espaces communs ou auditoriums. Les gradins comprennent également un espace de rangement multifonctionnel. Avec option de tapisserie de l'assise en tissu ou semi-cuir.



BERG

With a metallic structure and colorful trays, this bench is a practical solution for easy, clean and organized storage.

The stylish Berg Bench includes the option of a cushion for extra seating comfort. Includes 4 casters for easy transport.



Avec structure en métal et bacs colorés, ce banc est une solution pratique pour le rangement facile, propre et organisé. L'élégant banc BERG inclut une option coussin pour un confort d'assise extra. Banc à roulettes, pour déplacement facile.

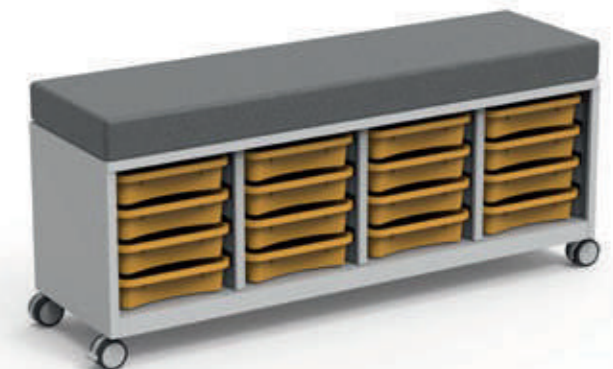

SOFT SEATING / POUFS

BLOCK

Outfit your spaces with our BLOCK soft seating. Distribute and organize your space, according to the size of each room. Ideal for combining with BOX cabinets, creating soft seating areas with suitable storage spaces.

Aménagez vos ambiances avec les poufs BLOCK. Répartissez et organisez l'espace, selon la taille et le design de chaque pouf. Idéal pour combiner avec les armoires BOX, créant des zones d'assise en mousse avec des espaces de rangement adéquats.

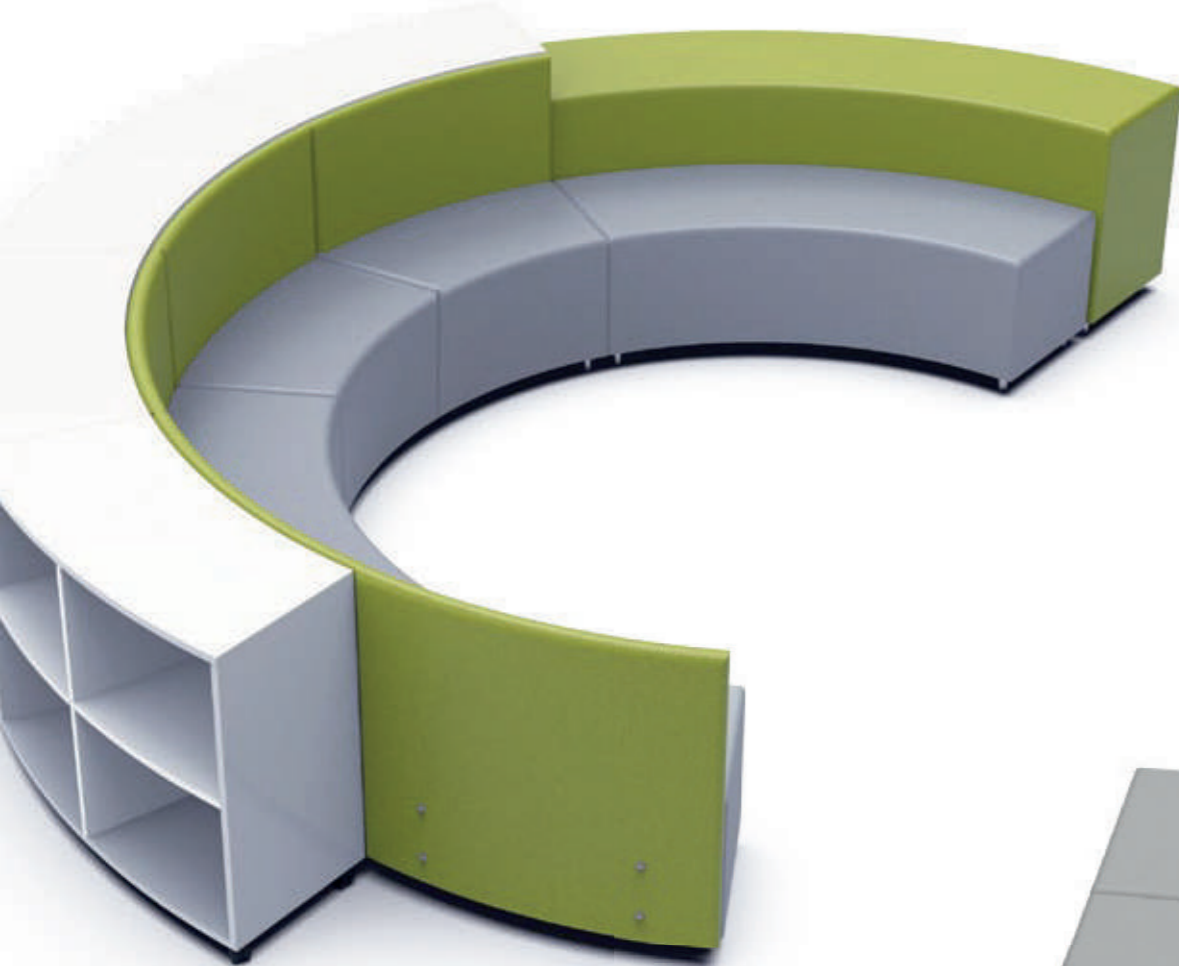

5x BLOCK: BLCPI
1x BLOCK: BLC (T6 : L 1642)
1x BLOCK: BLC (T8 : L 2128)
4x BOX: BCE/BCET

3x BLOCK: BLB



4x BLOCK: BLRE



MUTE

The MUTE panels allow for a variety of forms and configurations. They can be used to create enclosed spaces or act as a simple divider, or even as a simple sound buffer. They can also be combined with BOX cabinets and with the BLOCK range of soft seating.

Acoustic panels available in a variety of colors and shapes.



Les cloisons MUTE permettent une variété de formes et configurations. Ils peuvent être utilisés pour créer des espaces fermes ou comme un séparateur. Ils sont également combinables avec les armoires BOX et la gamme BLOCK

Les panneaux muraux acoustiques sont disponibles en différentes couleurs et formats.

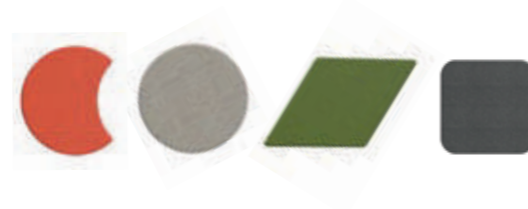

4x MUTE: MF
4x DESK21
4x ERGOS SHELL: SH4

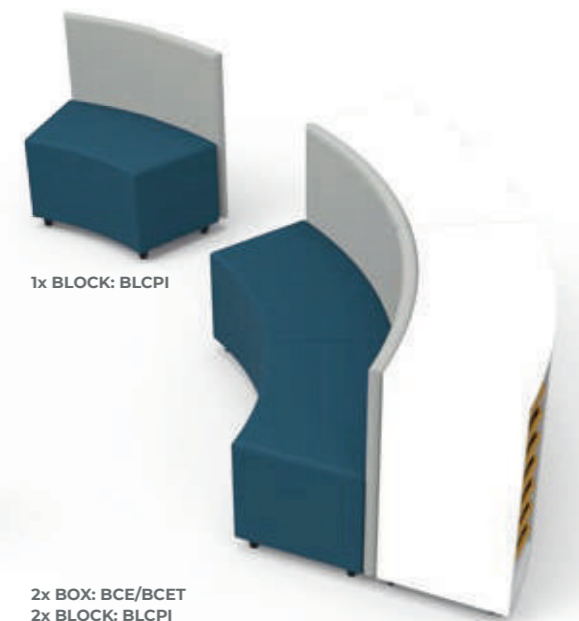

1x BLOCK: BLCPI

2x BOX: BCE/BCET
2x BLOCK: BLCPI



5x MUTE: MF
2x DESK 21: D21 IR
2x ERGOS SHELL: SH4



4x MUTE: MALF
1x TEAM: MTT
3x BLOCK: BLRD

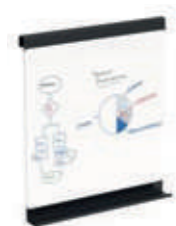

MUTES
WRITING SCREEN
TABLEAU D'ÉCRITURE



MUP
SHELF
ÉTAGÈRE



MUCAB
HOOK
CROCHET



MUS
SUPPORT A4
SUPPORT A4



MUPL
PENCIL HOLDER
PORTE-CRAYONS

Supports / Supports



Connectors / Branchements



DIDAX®

Applied to different structures or directly onto the wall, the writing enamel surfaces (in steel plate, vitrified at 800 ° C), are dry erase and magnetic, ideal for intensive use. This surface can also be used as a projection screen.



Appliquées sur différentes structures ou directement sur le mur, les surfaces émaillées d'écriture (en tôle d'acier, vitrifiée à 800 ° C), sont effaçables à sec et magnétiques, idéales pour un usage intensif. Cette surface peut également être utilisée comme écran de projection.



* Writing screen applied to the wall.
* Toile d'écriture accrochée au mur



Structures with castors
Structures roulantes



Magnetic surfaces
Surfaces magnétiques



Dry erase
Effaçage à sec



Easy cleaning
Facile à nettoyer



Surface for projection
Surface de projection

* For correct application, it is important that the walls are completely smooth and without undulations.
* Pour une utilisation correcte, il est important que les murs soient totalement lisses et sans aspérités.



NETBOARD

The use of technology in the classroom allows working with dynamic content, adapted to different learning paces, sharing and reusing of resources produced, to encourage participation and cooperation between students. NAUTILUS offers different interactive products for every classroom, from boards and tables to device charging and storage solutions.

L'usage de la technologie en classe permet de travailler avec des contenus dynamiques, adaptés aux différents rythmes d'apprentissage, de partager et de réutiliser les ressources produites, d'encourager la participation et NAUTILUS propose différents produits interactifs pour chaque salle de classe, des tableaux et tables aux solutions de chargement et de stockage des appareils.



65" 4K, 75" 4K and 86" 4K Technology.

Provides an intuitive user experience through a unified menu that allows simplified navigation, with easy access to all applications and content. The built-in Android™ 8 operating system provides new levels of speed, security and reliability.

Via USB-C we can see, hear, interact, and charge the laptop with just a single cable.

Technologie 4K de 65", 4K de 75", 4K de 86".

Ces produits offrent une expérience d'utilisation intuitive au travers d'un menu unifié permettant une navigation rapide et simplifiée, avec un accès facile à toutes les applications et tous les contenus. Le système d'exploitation Android™ 8 incorporé propose de nouveaux niveaux de vitesse, sécurité et fiabilité. Grâce à une prise USB-C, vous pourrez voir, écouter, interagir et recharger votre ordinateur portable avec un seul câble.

Promethean



NB NEW BASIC FP

Interactive Wall Station, height-adjustable on assembly, with weight unloading to the ground.

Station interactive murale, réglable en hauteur lors du montage, déchargement du poids au sol.

NB FLOW FLIP

Adjustable in height (70cm stroke) and inclination by electric motor with command. Central lifting column (17x15 cm). 70x60 cm support, tilting at 90°. Epoxy paint finish epoxy finish. 4 polyamide casters.

Réglable en hauteur (courseur de 70 cm) et inclinable par moteur électrique à commande. Colonne d'élévation centrale (17 x 15 cm). Table de 70 x 60 cm, basculant à 90°. Finition en peinture époxy. 4 roulettes en polyamide.



NB NEW BASIC M

Mobile stand. Monitor support in sheet steel. Base and shelf in compact melamine with PVC edging. 4 polyamide wheels.

Support amovible. Table de support de moniteur en plaque d'acier. Base et plateau en compact mélaminé à bords en PVC. 4 roulettes en polyamide.





TECNOLOGY | TECHNOLOGIE

NETBOARD

NETBOARD PORTABLE

All-in-one solution composed of a unique structure (registered model) that incorporates an interactive projector, allowing its use on the floor, on a table or on the wall. It can also integrate a microcomputer, laptop or tablet. Students can intuitively interact with educational content on various surfaces, developing their motor, cognitive and social skills.



Solution complète « all-in-one » composée d'une structure exclusive (marque déposée) qui incorpore un projecteur interactif, permettant son utilisation au sol, sur une table ou mur. Vous pouvez également intégrer un microordinateur, ordinateur portable ou tablette. Les élèves peuvent interagir intuitivement avec du contenu éducatif sur diverses surfaces, développant leurs capacités



NBPORT1 (AIO) NBPORT2 (LAPTOP) NBPORT TRL



NBPORT-MT



NETPOWER



Interactive solution, with an AIO computer and multi-touch screen that can be used as a student desk or pulpit. Adjustable in height, it adapts easily to different users. It can be connected to a projector and pc already in the classroom

Solution interactive, avec un ordinateur AIO et un écran tactile multipoint pouvant être utilisé comme table scolaire ou pupitre. Réglable en hauteur, il s'adapte facilement aux différents utilisateurs. Peut être connecté à un projecteur et un PC déjà dans la classe





TECHNOLOGY | TECHNOLOGIE

DOK STATION

DOK STATION has a unique feature that allows the screen to slide down on the table, ideal for working in touch mode and also to allow to permanently look at the teacher. DOK STATION offers integration, versatility and security, as it is a 2 in 1 table: writing desk and computer desk. Computer, screen, keyboard and mouse are easily hidden and secure.



DOK STATION est unique dans sa conception permettant à l'écran de sortir de la table et glisser sur celle-ci. Idéal pour travailler en mode tactile et aussi pour permettre de regarder en permanence l'enseignant. DOK STATION offre intégration, polyvalence et sécurité car c'est une table 2 en 1: table d'écriture et table d'ordinateur. L'ordinateur, l'écran, le clavier et la souris sont facilement cachés et sécurisés.



Table lock

Verrouillage supérieur

Automatic elevation and inclination of the screen after opening the table

Élévation et inclinaison automatiques de l'écran après ouverture de la table

Mouse and keyboard storage

Rangement du clavier et de la souris

Electric tilt control and monitor elevation buttons

Boutons de commande électrique pour l'inclinaison et la rétractation de l'écran





TECHNOLOGY | TECHNOLOGIE

NETBOOK | NETSTATION



Storage and charging solutions for laptops, tablets, cell phones or combined. The simplicity of use is the big plus: it comes to you completely assembled and its operation is very simple. Solidly constructed cabinets that are easy to move.



NETBOOK BUS 40 / 32 / 24 / 16
40, 32, 24, 16 divices up to 17"
40, 32, 24, 16 dispositifs jusqu'à 17"



NETBOOK NB15
15 divices up to 14"
15 dispositifs jusqu'à 14"

Des solutions de rangement et de rechargement d'ordinateurs portables, tablettes, téléphones portables ou dispositifs combinés. La simplicité d'utilisation est une grande plus-value : livrés entièrement montés, leur fonctionnement est très simple. Armoires à la construction solide et faciles à manipuler.



NETSTATION
16 laptops de 15,6" or 32 tablets
16 ordinateurs portables de 15,6" ou 32 tablettes



STURDINESS
Resistant and fire-retardant manufacturing structures.

ROBUSTESSE
Structures résistantes et ignifuges.



READY TO USE
No need to spend time on assembly.

PRÊT À L'EMPLOI
Pas de temps à perdre avec le montage.



UNIVERSAL
Guaranteed compatibility.

UNIVERSEL
Compatibilité garantie.



PROTECTION
Circuit breakers and differential for user and equipment protection.

PROTECTION
Disjoncteurs et différentiel pour la protection de l'utilisateur et des équipements.



SPEED AND EFFICIENCY
Fast storage and efficient with space for devices up to 17".

RAPIDITÉ ET EFFICACITÉ
Rangement rapide et efficace avec un espace pour des dispositifs jusqu'à 17".



SAFETY
Locking doors and protection of electrical components.

SÉCURITÉ
Blocage des portes et protection des composants électriques.



ACCESSIBILITY
Wide doors and shelves for easy access.

ACCESSIBILITÉ
Portes et étagères larges pour un accès facile.



NETBOOK BUS SMART EDITION



REFERENCES / RÉFÉRENCES

TABLES / TABLES

DESK 21

D21 I



*D21 70 x 70 x (h) D21 IB 70 x 70 x (h) D21 IR 70 x 50 x (h) D21 IT 70 x 70 x (h) D21 IT8 90 x 50.8 x (h)



D21 IT6 84 x 49 x (h) D21 IC8 84 x 50 x (h) D21 IC6 74 x 48 x (h) D21 FB06T 120 x 60 x (h)

D21 U



D21 URI 80 x 60 x (h) D21 URD 120 x 65 x (h) D21 UM 120 x 60 x (h) D21 UMO 130 x 69 x (h) D21 URO 130 x 73 x (h)



D21 UT 130 x 56x (h) D21 UC 130 x 72 x (h) D21 UE Ø 130 x (h) D21 UH 130 x 113 x (h) D21 ULF Ø 130 x (h)

h cm T02: 52 | T03: 58 | T04: 64 | T05: 70 | T06: 76 | T07: 82 | *T08: 89 | *T09: 98 | *T10: 107

Compacmel®

TABLE TOP | PLATEAU

White
Blanc Grey
Gris



STRUCTURE | STRUCTURE

Anthracite
Anthracite Grey
Gris



D21 - TEACHER / PROFESSEUR



DESK 21 FH01 120 x 60 x 76 DESK 21 FH0IT 120 x 60 x 76 DESK 21 FH0IG 120 x 60 x 76

Compacmel®

TABLE TOP | PLATEAU

White
Blanc Grey
Gris



STRUCTURE | STRUCTURE

Anthracite
Anthracite Grey
Gris

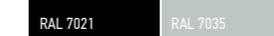

MAIS



MAIS FA 75 x 60 x (h) MAIS FAIM 75 x 60 x (h) MAIS FAIMP 75 x 60 x (h) MAIS UNI FA 75 x 60 x (h)

h cm T04: 64 | T05: 70 | T06: 76

STRUCTURE | STRUCTURE

Anthracite
Anthracite Grey
Gris



TABLE TOP | PLATEAU

PP



ERGOS



ERGM1 75 x 60 x (h)

h cm T01: 47 | T02: 54 | T03: 61

TABLE TOP | PLATEAU

PP



PP



REFERENCES / RÉFÉRENCES

TABLES / TABLES

TEAM



MTI 70 x 55 x 64-76



MTD 130 x 55 x 64-76



MTT 195 x 60 x 64-76

h cm T04: 64 | T05: 70 | T06: 76

TEAM - TEACHER / PROFESSEUR



MTPPI 70 x 55 x 76



MTPPI 70 x 55 x 76



MTPIT 70 x 55 x 76



MTPD 130 x 55 x 76



MTPDP 130 x 55 x 76



MTPDT 130 x 55 x 76



MTPPIA 70 x 55 x 102



MTPPAP 70 x 55 x 102



MTPPAT 70 x 55 x 102

Compacmel®
TABLE TOP | PLATEAU

White
Blanc

Grey
Gris

STRUCTURE | STRUCTURE

Anthracite
Anthracite

Grey
Gris

RAL 7021

RAL 7035

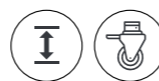

FLOW



MFE

w: 120 | 140 | 160 | 180 d: 60 | 70 | 80



MFED

w: 120 | 140 | 160 | 180 d: 126 | 146 | 166

Compacmel®

TABLE TOP | PLATEAU

White
Blanc

Grey
Gris

STRUCTURE | STRUCTURE

White
Blanc

Anthracite
Anthracite

Grey
Gris

h cm 75 - 125

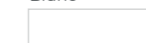

HT



HT 120 x 60 X 76

Other dimensions under request
Autres dimensions sur demande

TABLE TOP | PLATEAU

Compacmel®

White
Blanc

Grey
Gris

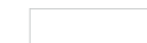

LAMINATE | STRATIFIÉ

Grey
Gris

Beech
Hêtre

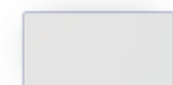

Option | Option:
EDGE Tabletop (PP edges)
Plateau EDGE (bords EN PP)

STRUCTURE | STRUCTURE

White
Blanc

Grey
Gris

Anthracite
Anthracite

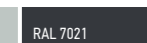
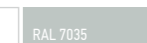
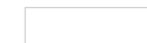

EDGE - TABLE TOPS / PLATEAU

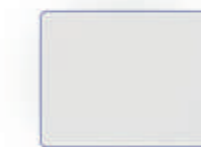

TEI 75 x 60



TEIA 75 x 60

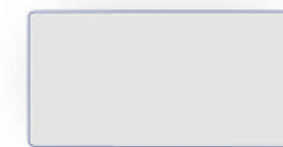

TED 120 x 60



TEDA 120 x 60

TABLE TOP | PLATEAU
LAMINATE | STRATIFIÉ

Grey
Gris

Beech
Hêtre

PP

432

427

661



"Q3" (TEIF)



"UNI_STEP" (TEIAR)



REFERENCES / RÉFÉRENCES

CHAIRS / CHAISES

ERGOS ONE



01 30 x 32 **02** 30 x 36 **03** 42 x 38 **04** 42,5 x 41 **05** 50 x 50 **06** 50 x 50 **07** 50 x 50

h cm T01: 27 | T02: 31 | T03: 35 | T04: 38 | T05: 43 | T06: 46 | T07: 51

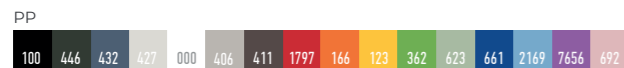

T05 | T06 | T07
LINKING SYSTEM
SYSTÈME DE RACCORDEMENT



ERGOS SHELL



BASE (SH4) 49 x 50/52 x (h) **BASE RB (SHBR)** 51 x 54 x (h) **POLE (SHC)** 52 x 53 x (h) **ROCKING (SHRKA)** 52 x 57 x (h) **ROCKING S (SHRKB)** 49 x 65 x 23 **PATIM (SHPT)** 53 x 52 x 46 **NOTE (SHPCPB)** 59 x 73 x 46



BASE (SH4A) 49 x 53 x 65/75 **SPIN (SHPC)** 63 x 63 x 42-52 **SPIN A (SHPCR)** 63 x 63 x 65-89 **SPIN B (SHPCB)** 63 x 63 x 42-52 **SPIN AB (SHPCBR)** 63 x 63 x 65-89 **SPIN P (SHPCP)** 67 x 74 x 42-52 **SPIN AP (SHPCPR)** 67 x 74 x 65-89

h cm T05: 43 | T06: 46 | T07: 51

STRUCTURE | STRUCTURE

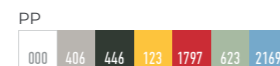

Compacmel®

WRITING SURFACE | SURFACE D'ÉCRITURE

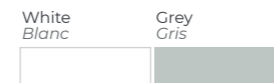

MAIS



MAIS AA 47 x 50 x (h) **MAIS AC** 51 x 51 x (h) **MAIS UNI AA** 48 x 51 x (h) **MAIS UNI AAR** 48 x 51 x (h) **MAIS UNI B** 48 x 51 x (h) **MAIS R** 63 x 63 x 40-50



MAIS AH 21 47 x 50 x 65 **MAIS AH 23** 40 x 42 x 55-65 **MAIS BA** 44 x 50 x 65

h cm T04: 38 | T05: 43 | T06: 46

STRUCTURE | STRUCTURE



BENCHES / BANCS

STAND



BLSIR 80 x 50 x 54 **BLSP2R** 80 x 100 x 94 **BLSP3R** 80 x 150 x 134

UPHOLSTERY | TAPISSERIE
Fabric or semi-leather
Tissu ou semi-cuir

STRUCTURE | STRUCTURE

Melamine



REFERENCES / RÉFÉRENCES

BENCHES / BANCS

BERG



BERG02
72 x 41 x 51

BERG03
106 x 41 x 51

BERG04
141 x 41 x 51

STRUCTURE | STRUCTURE

Anthracite
Anthracite

Grey
Gris

PP

123 661 362 1797



STORAGE / RANGEMENT

BOX



BCE
110,5 x 49 x 81,5

BCET
110,5 x 49 x 81,5

BCI
84,5 x 47,5 x 81,5

BCIT
84,5 x 47,5 x 81,5

BR6
104 x 43,5 x 81,5



BR4T
104 x 43,5 x 81,5

BR4
70 x 43,5 x 81,5

BR2T
70 x 43,5 x 81,5

BRA
104 x 43,5 x 195

BCEA
110,5 x 49 x 195

BCIA
84,5 x 47,5 x 195

STRUCTURE | STRUCTURE

Melamine

White
Blanc

Grey
Gris

Beech
Hêtre

PP

123 661 362 1797



KUBIC



MM11
36 x 43,5 x 85

LN33
70 x 43,5 x 85

NM31
104 x 43,5 x 85

MM31RP
104 x 43,5 x 96

STRUCTURE | STRUCTURE

Melamine

White
Blanc

Grey
Gris

Beech
Hêtre

Metal

Anthracite
Anthracite

Grey
Gris

PP

123 661 362 1797



RETA



03.01.RMM

Accessories | Accessoires

METAL



03.82PA **03.08PIR** **03.08PR** **03.65R**

MELAMINE



03.08PIRMM **03.8PRMM**

MIXED

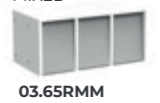

03.65RMM

METAL | METAL

White
Blanc

Grey
Gris

RAL 9016

RAL 7035

STRUCTURE | STRUCTURE

Melamine

White
Blanc

Grey
Gris

Beech
Hêtre

ATLANTIC



OPEN | OUVERT

ATL.A.19 (9)

ATL.A.12 (12)

ATL.A.15 (15)

CLOSED | FERMÉ

ATL.CA.9 (9)

ATL.CA.12 (12)

ATL.CA.15 (15)

2 DOORS | 2 PORTES

ATL.PB

METAL | METAL

White
Blanc

Grey
Gris

RAL 9016

RAL 7035

STRUCTURE | STRUCTURE

Melamine

White
Blanc

Grey
Gris

Beech
Hêtre



REFERENCES / RÉFÉRENCES

SOFT SEATING / POUFS

BLOCK

T02: 30 | T06: 45 | T08*: 70

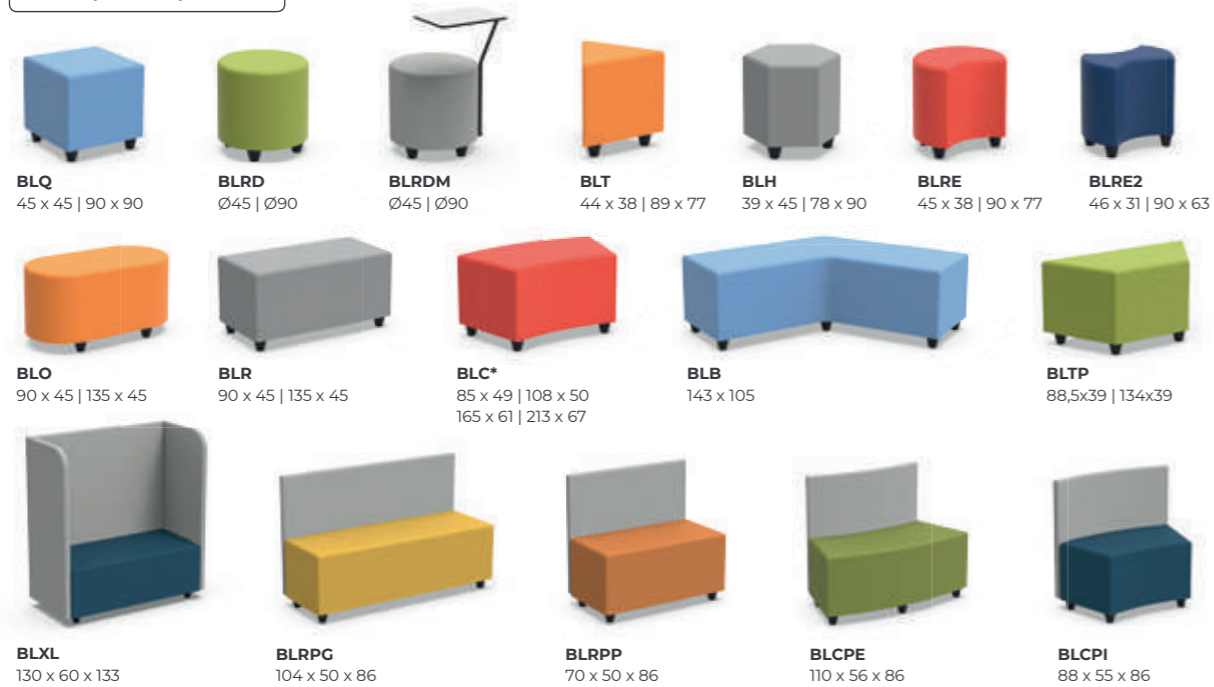

ACOUSTIC PANELS / CLOISONS ACOUSTIQUES

MUTE



WHITE BOARDS / TABLEAUX EFFAÇABLES

DIDAX



TECHNOLOGY / TECHNOLOGIE

DOK STATION | NETBOARD | NETBUS



REFERENCES / RÉFÉRENCES

DIGITAL LAB / ÉCOLE NUMÉRIQUE



Tripod 302 (Led)
Trépied 302 (Led)
TC302



LED lighting 500C
Éclairage LED 500C
ILG500C



Digital camera Sony ZV-1
Photo numérique Sony ZV-1
CAMSZV-1



3D printer Beeinschool
Imprimante 3D Beeinschool
IMP3DBS



Video conference system Logitech Meetup
Système de visioconférence Logitech Meetup
SVCLM



Content controller
Contrôleur de contenu
CTCONT



Robotic arm Rotrics Dexarm Luxury
Bras robotique Rotrics Dexarm Luxury
ROBLUX



Robotic arm Rotrics Dexarm Maker Kit
Bras robotique Rotrics Dexarm Maker Kit
ROBMAK



Robotic arm Rotrics Dexarm Starter Kit
Bras robotique Rotrics Dexarm Starter Kit
ROBSTA



Protection box Dexarm Laser
Boîte de protection Dexarm Laser
ROBCAI



Sliding rail Rotrics
Rail coulissant Rotrics
ROBTD



Conveyor belt Rotrics
Tapis roulant Rotrics
IMP3DBS



Chroma Key MT (2000 x 1800)
Chroma Key MT (2000 x 1800)
TCKMT



Lego Education construction set
Jeu de construction Lego Education
CCLEW



Codification set Matatalab
Jeu de codification Matatalab
MCCOD

COMPLEMENTS / COMPLÉMENTS



Mobile display
Affichage mobile
04.03S / 04.04S
92 x 47 x 154 / 179



Cork board
Tableau de liège
QC
90 / 150 / 200 / 250 x 120



Showcase display
Vitrine d'exposition
RA 02A
150 x 75



Acrylic shields
Protection en acrylique
RAC6 / RAC9
100 x 20 x 60 / 90



Door cabinet
Armoire à portes persienne
ATLPP
80 / 100 x 44 x 74 / 110 / 149 / 185



Door cabinet
Armoire à portes battantes
La 01 / La 02
100 x 44 x 85 / 185



Mixed closet
Armoire mixte
LG 02 / LG 03 / LG 04
80 / 100 x 44 x 160 / 185



Bookcase
Étagère
Pc 01
103 x 40 x 200



Drawing cabinet
Armoire à dessins
Li 01
100 x 80 x 85



Mobile Exhibitor Shelf
Étagère d'exposition mobile
NN 02
90 x 45 x 90



Umbrella holder
Porte-parapluies
RE 01
45 x 15 x 50



Paper basket
Corbeille à papier
Rd 01 NT
36 x 30 x 45



Cloakroom
Porte-manteau
05.14NT
30 x 30 x 174



Ruler of 8 hangers
Règle à 8 patères
RC 01 P
120 x 2 x 15



Ergos tray
Plateaux Ergos
T1 / T2
31 x 37,5 x 7,5 / 15,5



Conditioning foams
Mousses de conditionnement
TE



FINISHINGS / FINITIONS

Surfaces / Surfaces

MELAMINE MÉLAMINE

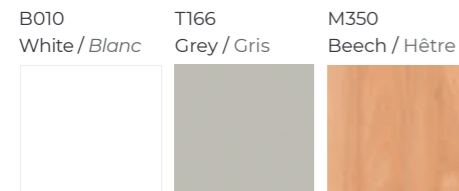

WOOD BOIS

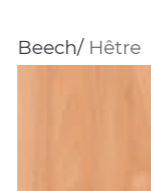

LAMINATED STRATIFIÉ

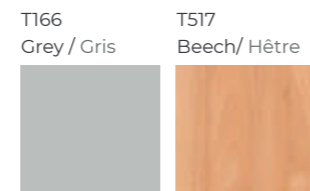

COMPACMEL COMPACMEL



Structures / Structures

PAINT | PEINTURE

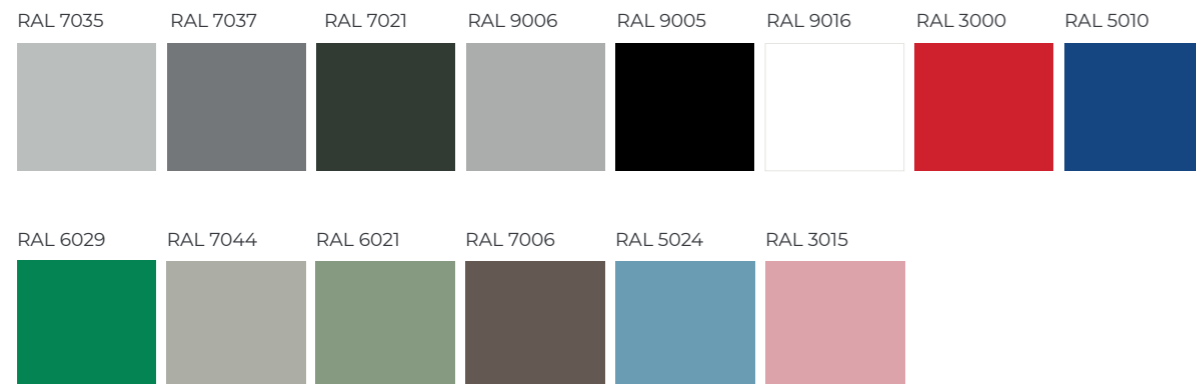

Polypropylene / Polypropylène

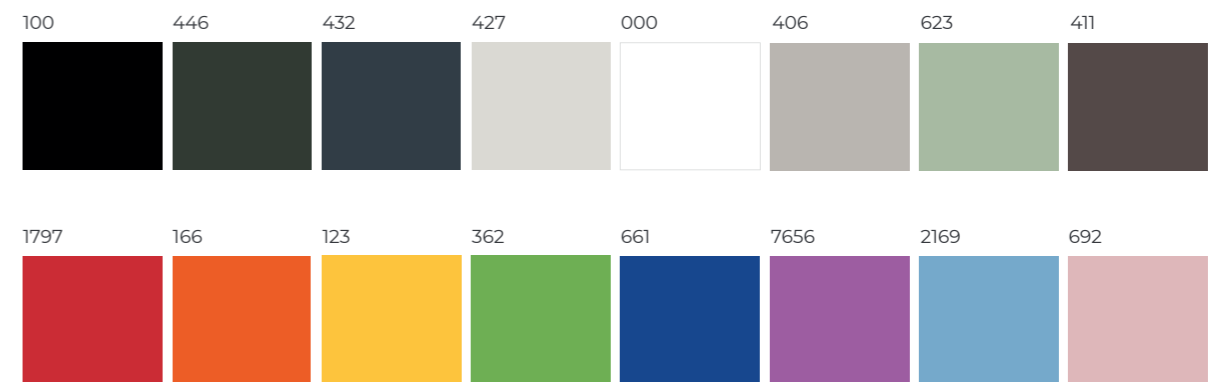

Upholstery / Tapissage

FABRICS | TISSUS



SEMI LEATHER | SEMI-CUIR

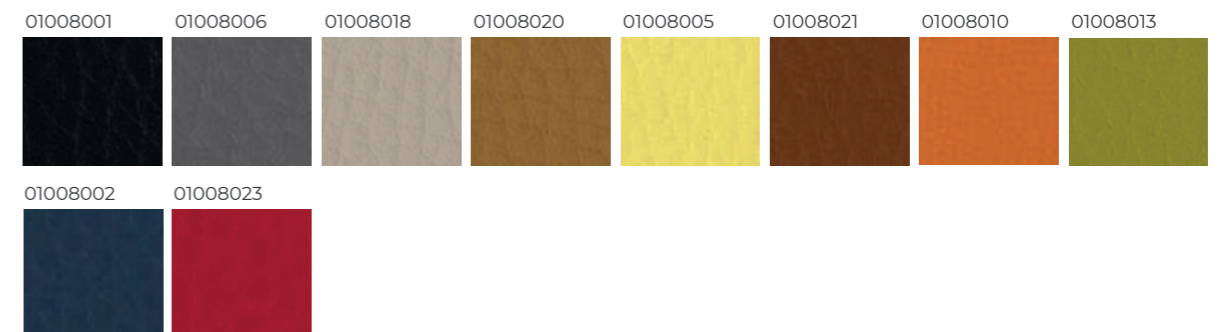



NAUTILUS | THE FUTURE IS EDUCATION

CHAIR AND TABLE MATCHUP GUIDE

GUIDE DE CORRESPONDANCE CHAISE ET TABLE

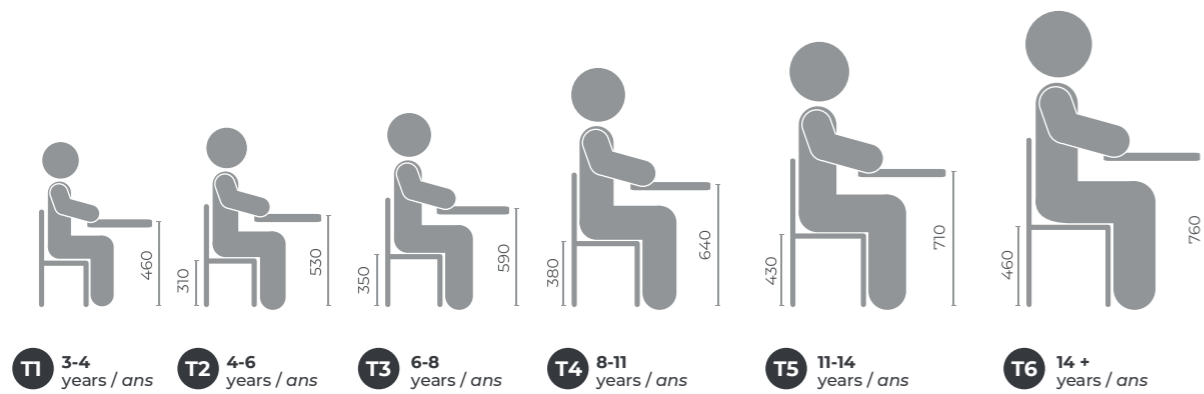



Pierre Stefanaggi
Email : adv@spoffice.net
Portable : 06.81.84.50.25
Site : www.spo-france.fr

